

CCAT: An Introduction

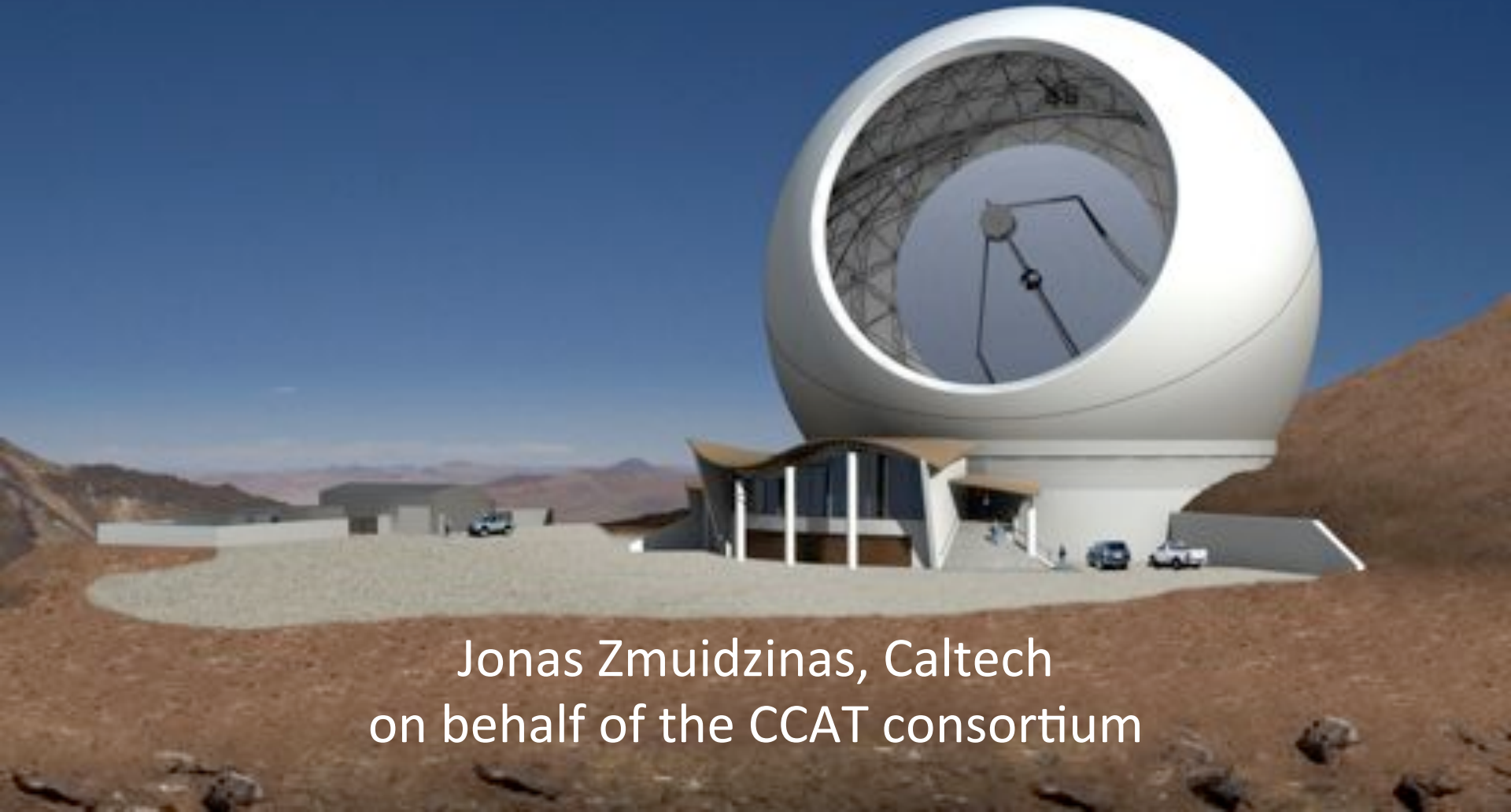

Jonas Zmuidzinas, Caltech
on behalf of the CCAT consortium

CCAT: quick facts

- 25m diameter
- 20' to 1 degree FOV
- 12 μm rms surface rms
- 0.2 – 2 mm wavelength range
- Cerro Chajnantor, Chile (5600 m)
- University consortium
 - Cornell, Caltech/JPL, Colorado, Canada, Cologne (& Bonn)
 - Will likely include US community participation, through NSF
- Key personnel
 - CCAT Board Chair: Jack Burns, Colorado
 - Director: Riccardo Giovanelli, Cornell
 - Project Manager: Jeff Zivick, Cornell
 - Project Engineer: Steve Padin, Caltech

A brief history of CCAT

- October 2003
 - Cornell & Caltech/JPL hold a workshop to discuss the case for a large, wide-field (25 m) submm telescope
- 2004
 - Cornell & Caltech sign MOU to perform feasibility study
 - hire PM and DPM
- 2005: Site selection & characterization
- January 2006
 - Feasibility study review, ~ \$100M cost estimate
- 2007-2010
 - Add partners (Colorado, Canada, Germany)
 - Continue technical work
- 2010
 - Astro2010 top-ranked medium-scale project
 - \$120M to \$140M cost estimate
- 2011: Entering detailed engineering design phase
- 2013: Start construction
- 2018: First Light

Early mm-wave astronomy

- 1961: Frank Low invents the Ge bolometer
- 1963: Sun, Moon, bright planets

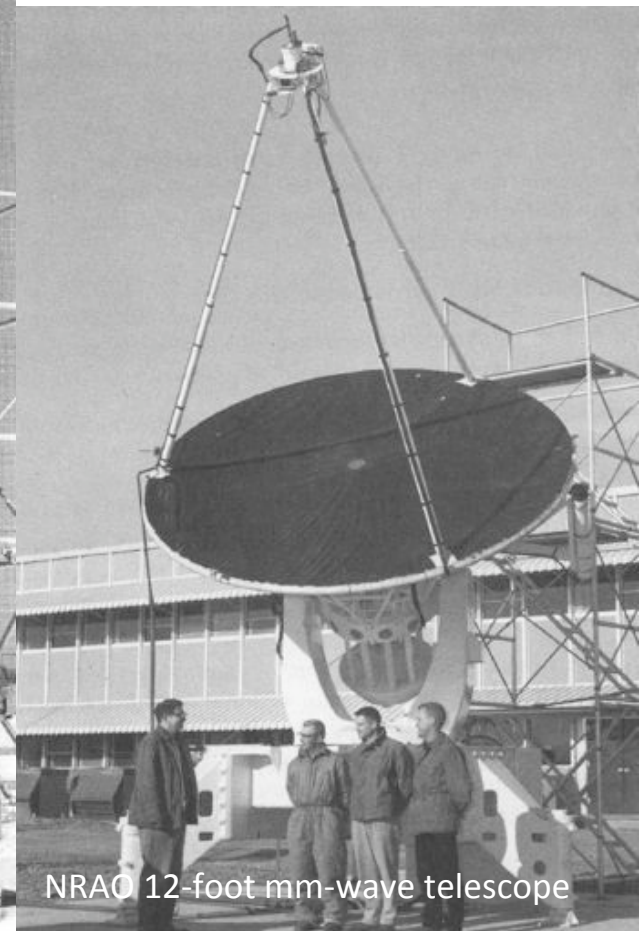
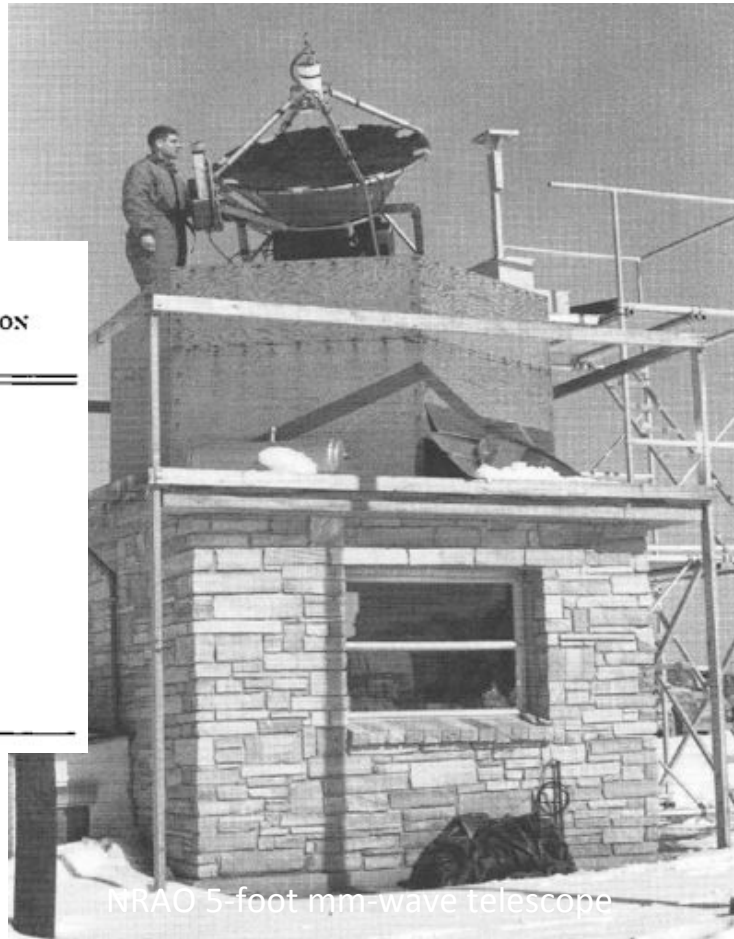

TABLE

N.R.A.O. MICROWAVE THERMAL-DETECTION
RADIOMETER

Center frequency = 250 GC ($\lambda = 1.2$ mm)
Bandwidth = ~ 35 per cent¹
 $\Delta T_{\min} = 0.015$ °K. rms for $\tau = 10$ seconds
1.2 mm Efficiency = 25 per cent
dc Bolometer Characteristics:
 $T_0 = 2.0$ °K
 $R_0 = 7$ by 10^6 Ω
 $G = 0.85$ μ watt/°K
 $\tau_B = 12$ ms
 $f_0 = 10$ c/s
Volume = 1.2 by 1.0 by 0.36 mm³
 $S = 1.3$ by 10^6 volts/watt
Noise = 5 by 10^{-4} volt/cs. rms
N.E.P. = 4 by 10^{-14} watt

Low & Tucker, 1968

VOLUME 21, NUMBER 22

PHYSICAL REVIEW LETTERS

25 NOVEMBER 1968

CONTRIBUTION OF INFRARED GALAXIES TO THE COSMIC BACKGROUND*

Frank J. Low

Department of Space Science, Rice University, Houston, Texas,
and Lunar and Planetary Laboratory, University of Arizona, Tucson, Arizona

and

Wallace H. Tucker

Department of Space Science, Rice University, Houston, Texas
(Received 12 July 1968)

The far-infrared background due to a superposition of infrared galaxies of the type recently observed is computed. It is shown that these galaxies contribute an amount of energy to the universe roughly equal to that radiated by the other galaxies and produce a far-infrared background peaking beyond 50μ . It is likely that they account for most of the observed extragalactic radio background but not the 3°K microwave background.

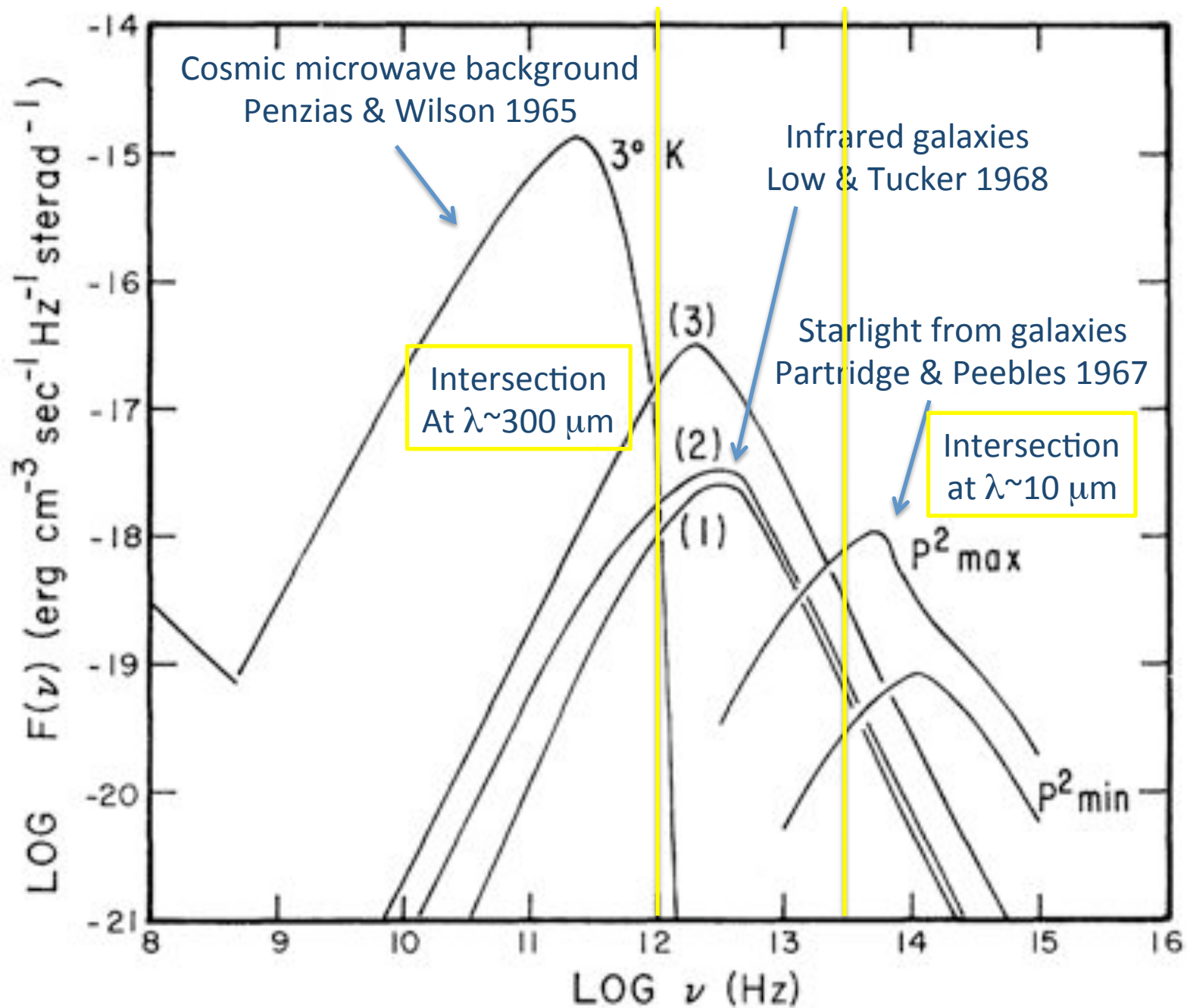

Light in the universe

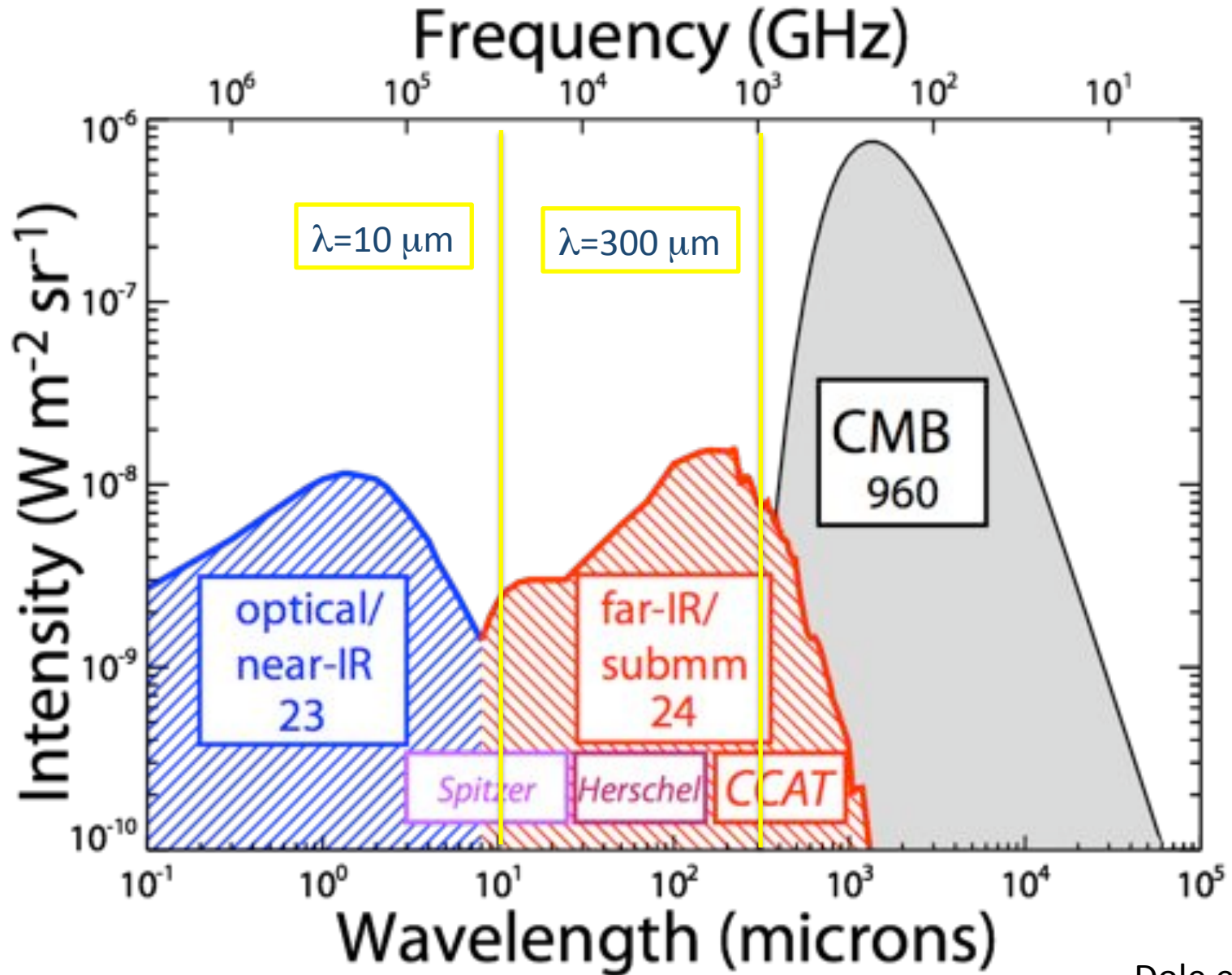

Richards' First Law

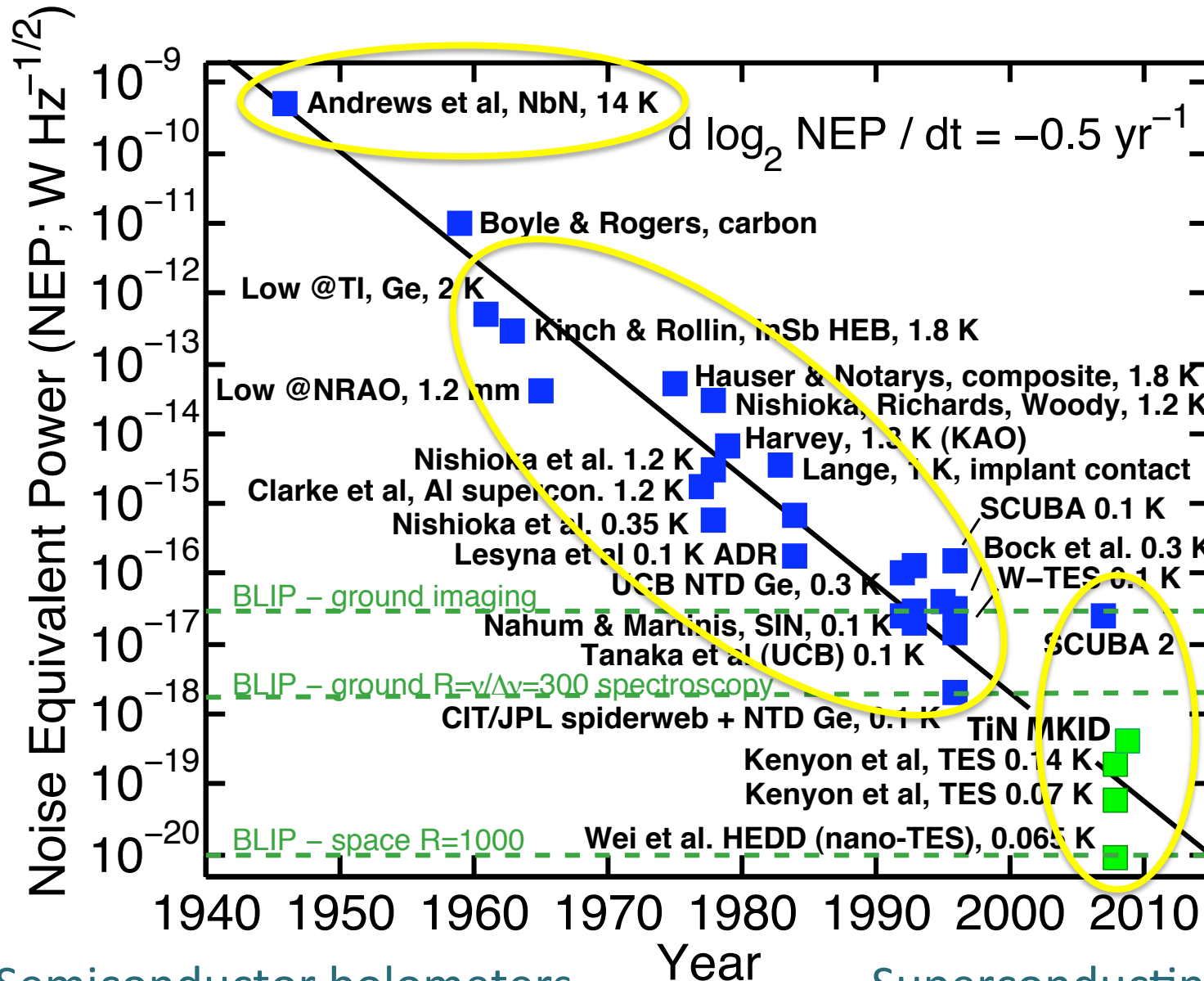

Semiconductor bolometers

Superconducting detectors



Herschel ATLAS SDP

The present: SCUBA 2 with 10k pixels

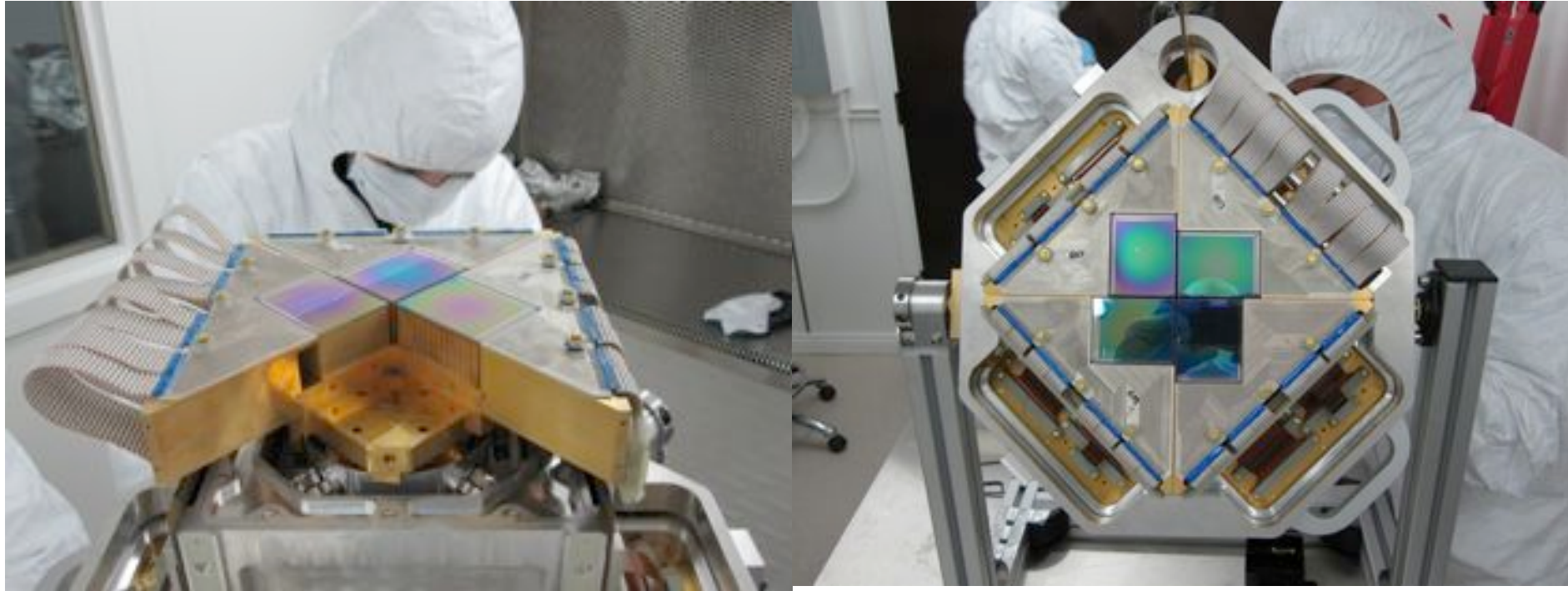

The future

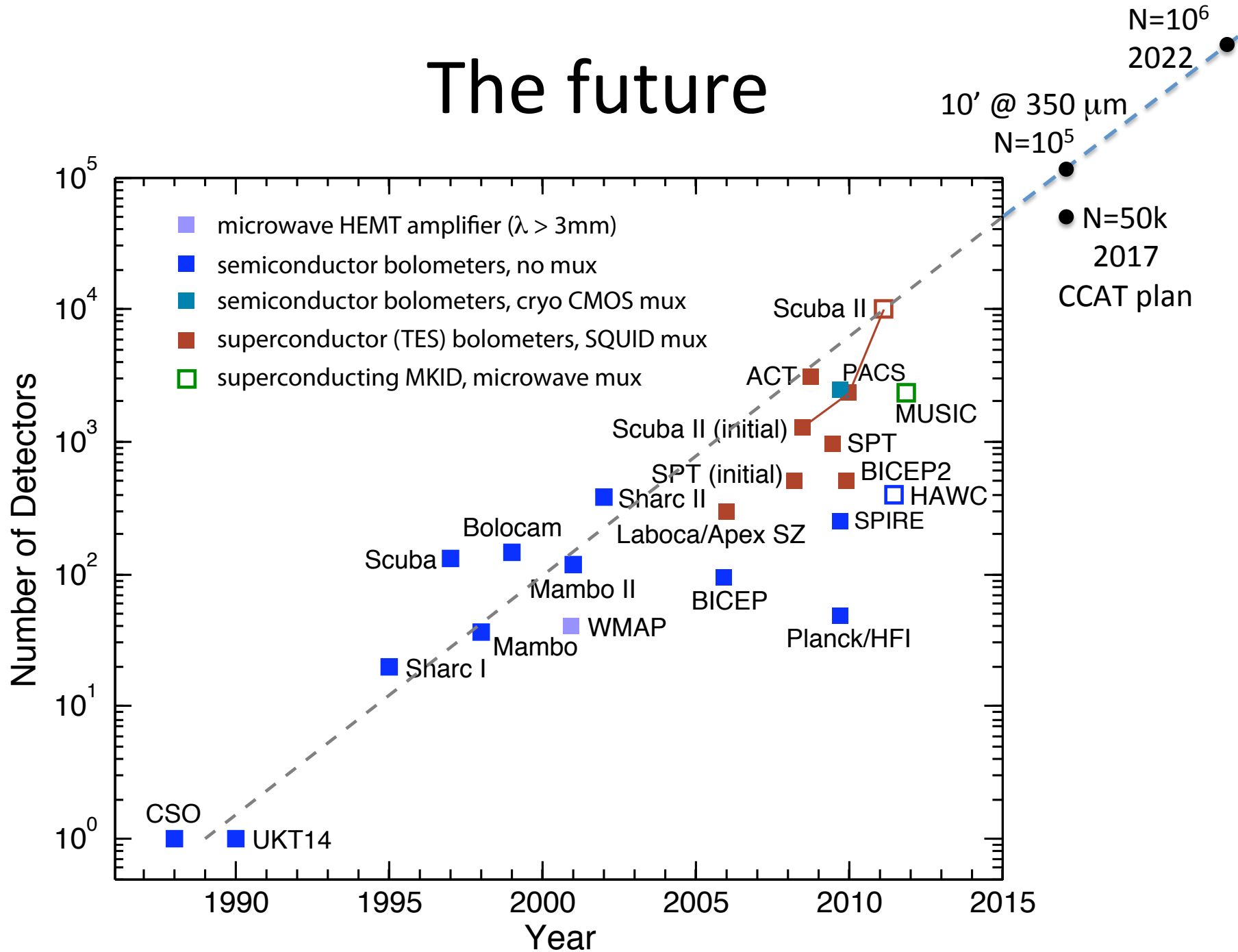

Telescope concept

HWFE $10\mu\text{m}$ rms, PE $0.35''$ rms

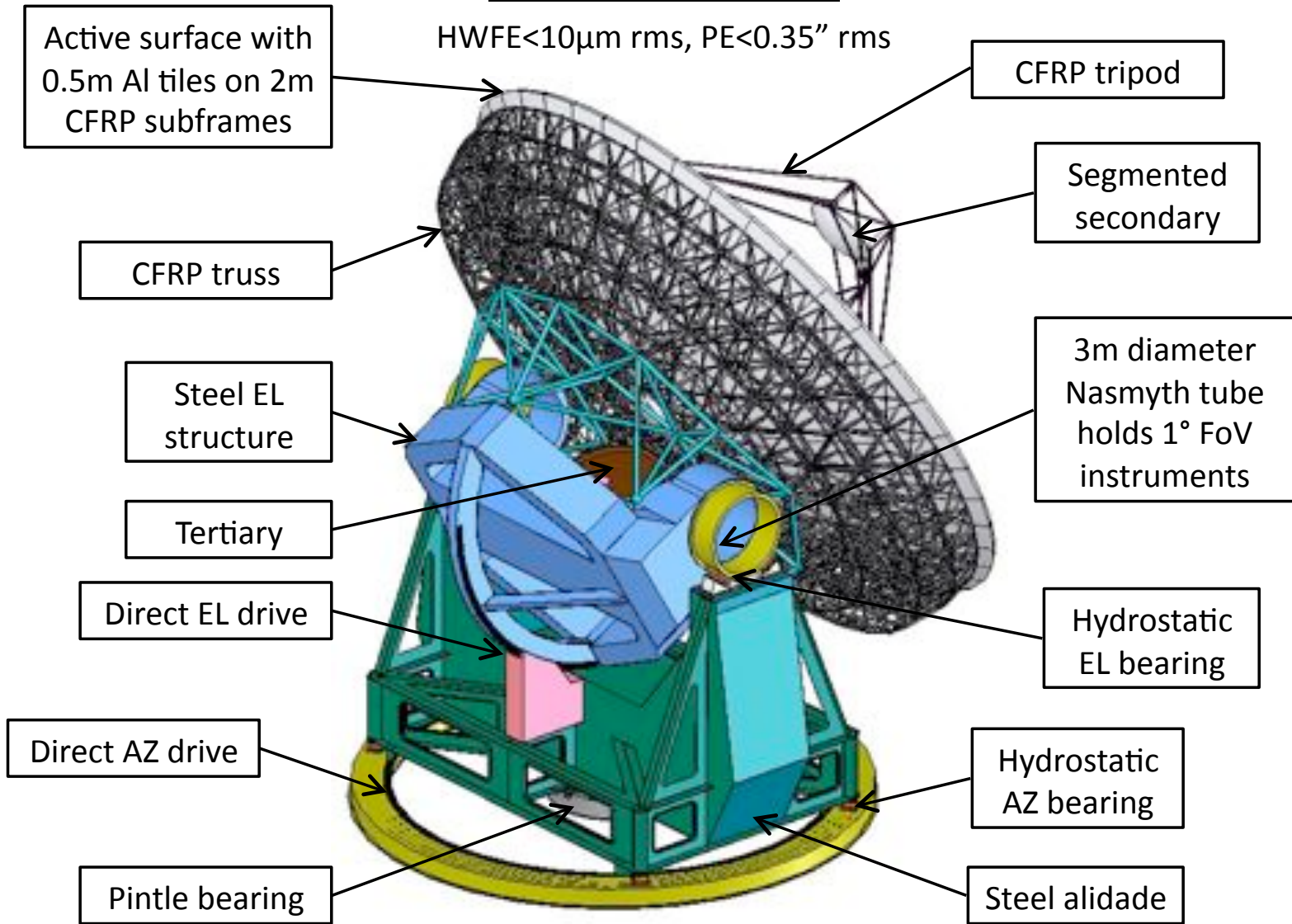

CCAT's wide field in context

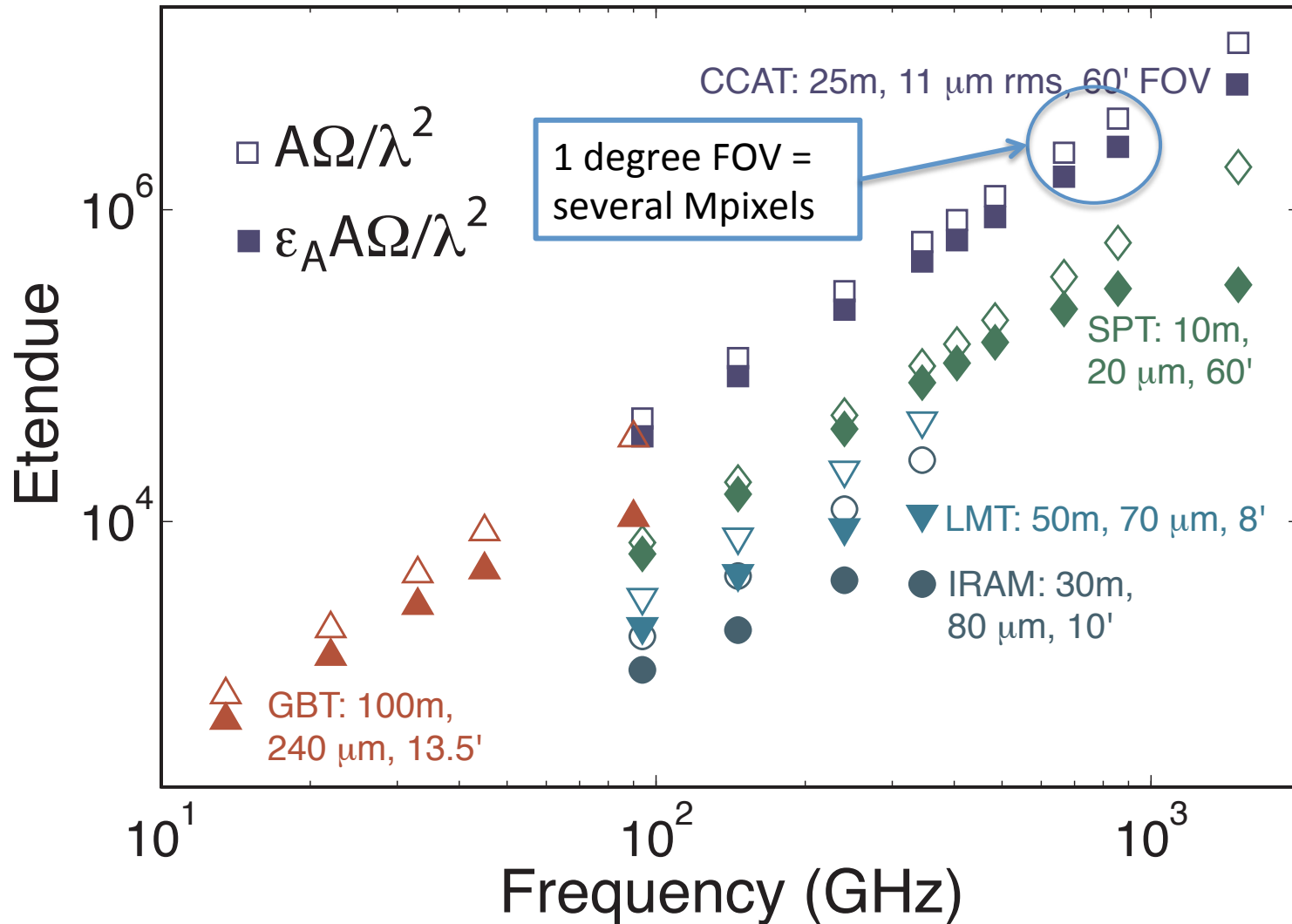

Field of view

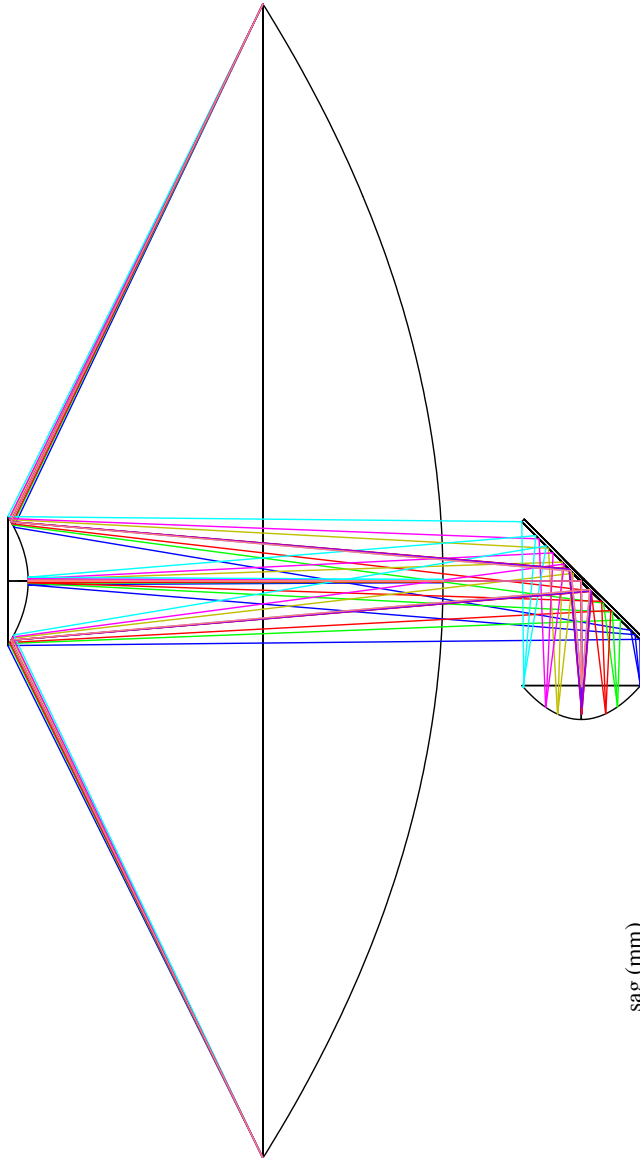

Strehl ratio vs. field angle for basic RC telescope

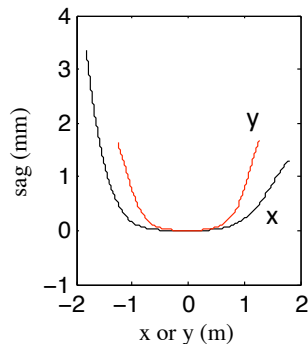
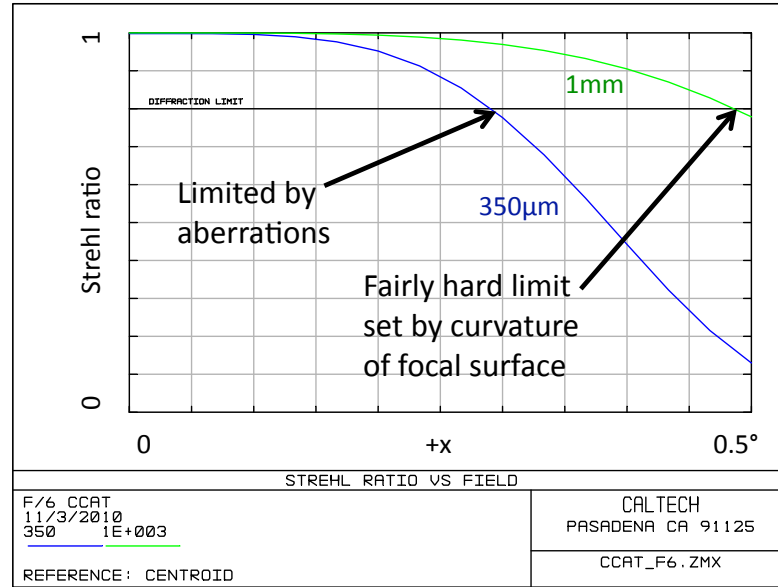

Tertiary profile to maximize FoV

Strehl ratio vs. field angle with tertiary corrector

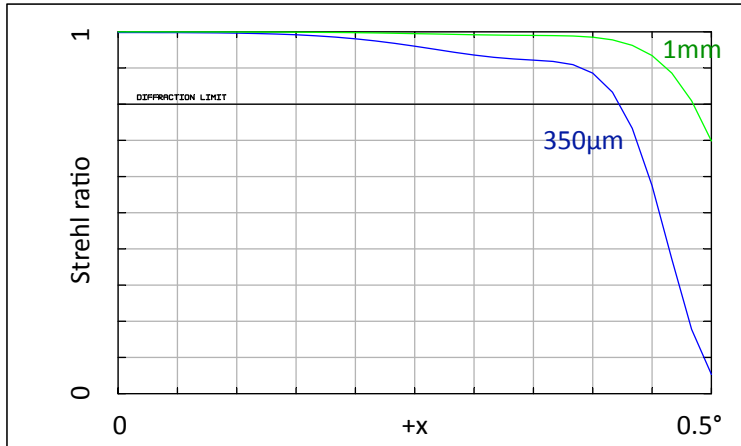

STREHL RATIO VS FIELD

F/6 CCAT WITH CORRECTOR 11/3/2010 350 1E+003	CALTECH PASADENA CA 91125	F/6 CCAT WITH CORRECTOR 11/3/2010 350 1E+003
REFERENCE: CENTROID	CCAT_F6_TERTIARY_CORR.ZMX	CCAT_F6_TERTIARY_CORR.ZMX

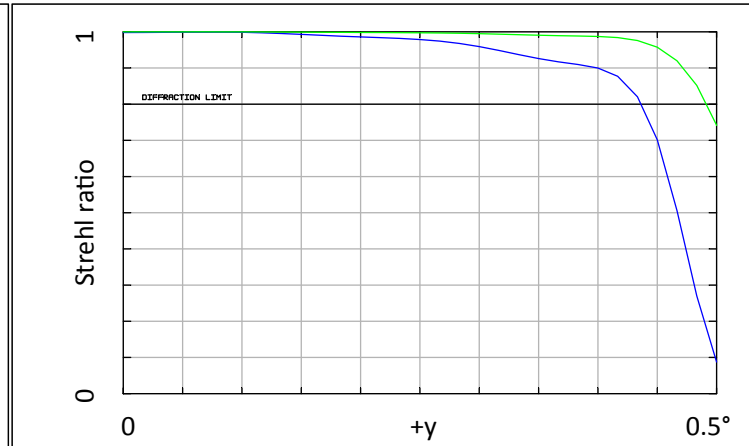

STREHL RATIO VS FIELD

F/6 CCAT WITH CORRECTOR 11/3/2010 350 1E+003	CALTECH PASADENA CA 91125	F/6 CCAT WITH CORRECTOR 11/3/2010 350 1E+003
REFERENCE: CENTROID	CCAT_F6_TERTIARY_CORR.ZMX	CCAT_F6_TERTIARY_CORR.ZMX

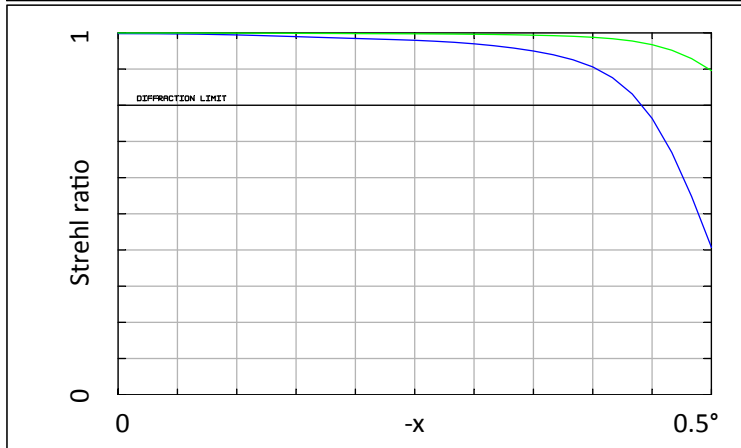

STREHL RATIO VS FIELD

F/6 CCAT WITH CORRECTOR 11/3/2010 350 1E+003	CALTECH PASADENA CA 91125	F/6 CCAT WITH CORRECTOR 11/3/2010 350 1E+003
REFERENCE: CENTROID	CCAT_F6_TERTIARY_CORR.ZMX	CCAT_F6_TERTIARY_CORR.ZMX

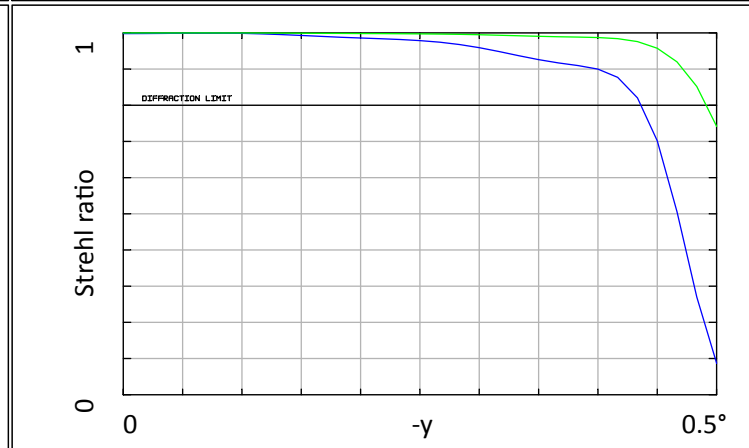

STREHL RATIO VS FIELD

F/6 CCAT WITH CORRECTOR 11/3/2010 350 1E+003	CALTECH PASADENA CA 91125	F/6 CCAT WITH CORRECTOR 11/3/2010 350 1E+003
REFERENCE: CENTROID	CCAT_F6_TERTIARY_CORR.ZMX	CCAT_F6_TERTIARY_CORR.ZMX

Camera relay with small HDPE lenses

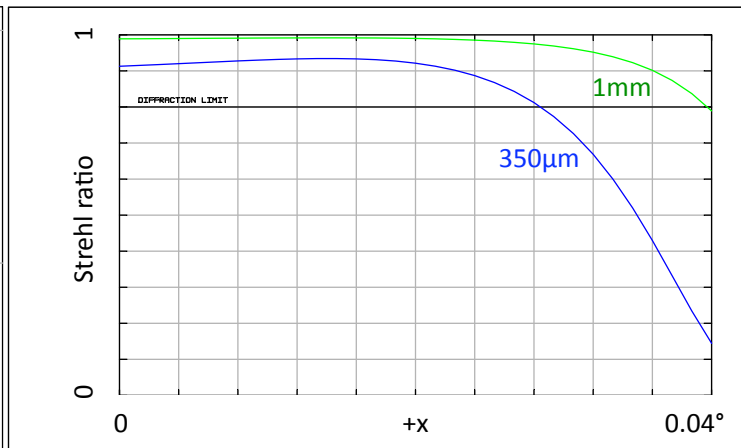
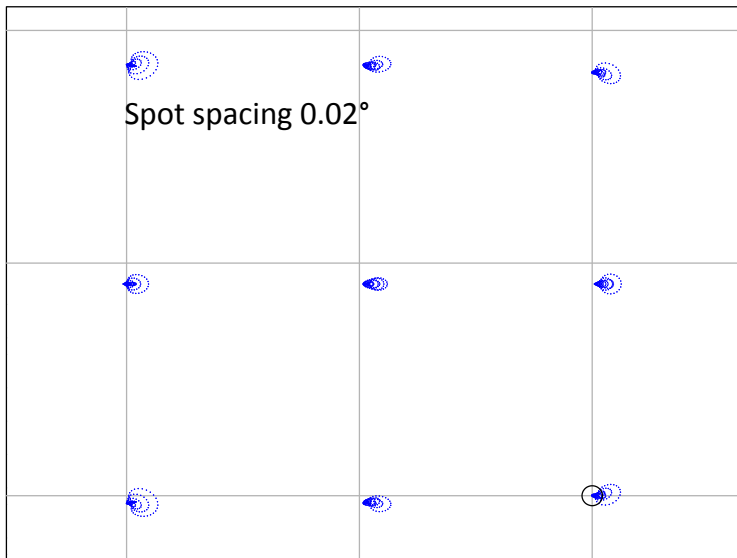
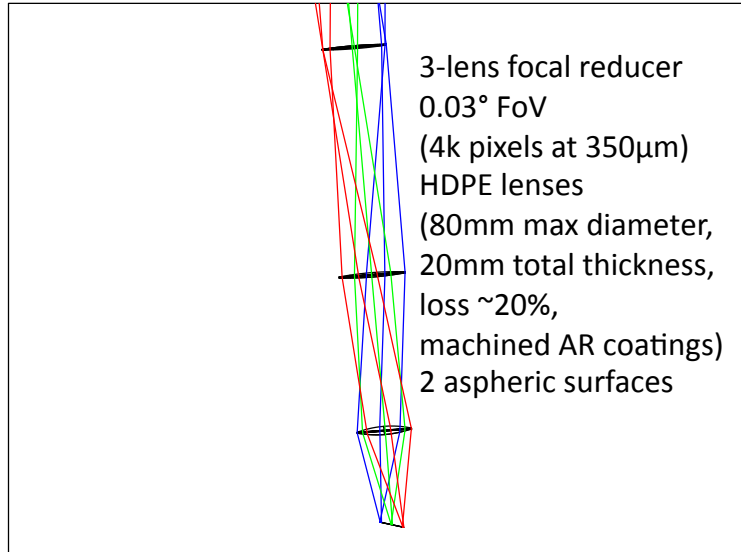
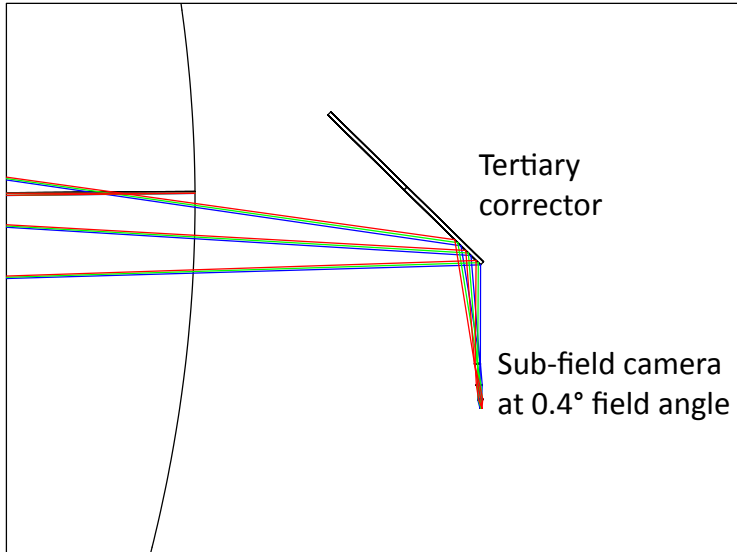

STREHL RATIO VS FIELD

F/6 CCAT WITH TERTIARY CORRECTOR	CALTECH
11/5/2010	PASADENA CA 91125
350 1E+003	CCAT_F6_TERTIARY CORR_3BCLENS_OFFSET.ZMX

REFERENCE: CENTROID

Frequency-multiplexed superconducting microresonator detectors (MKIDs)

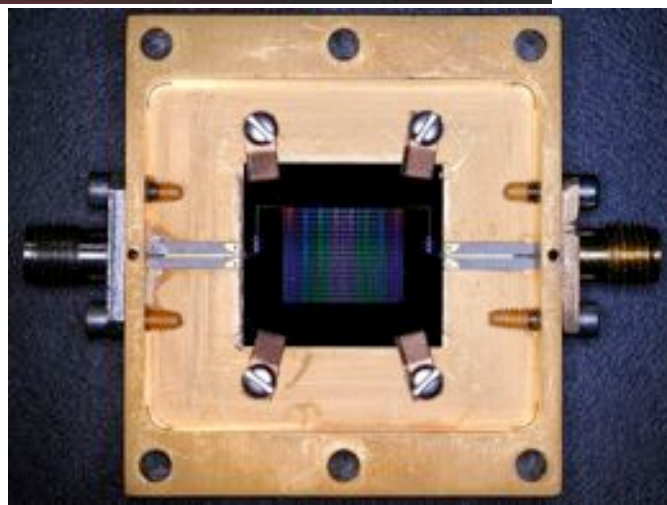
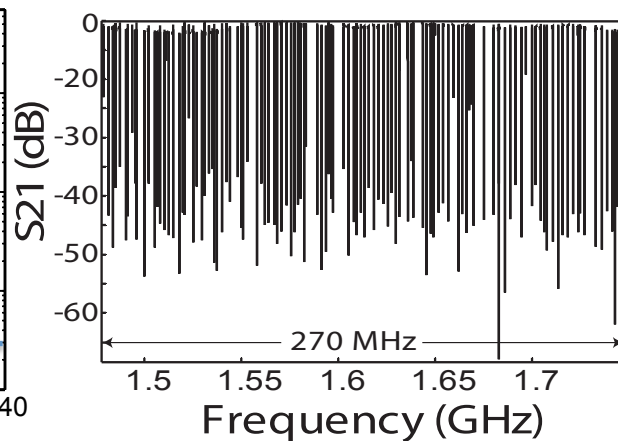
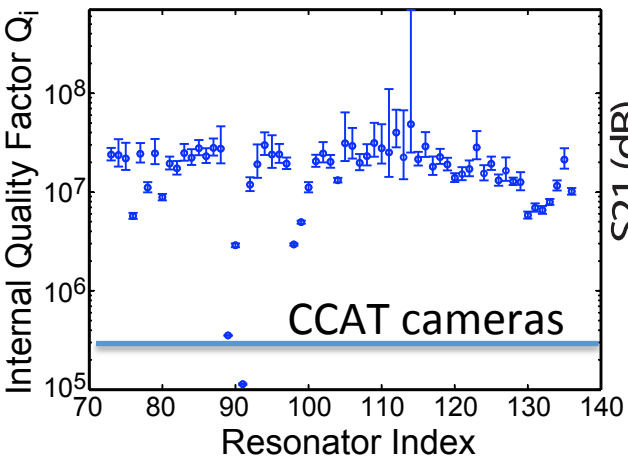
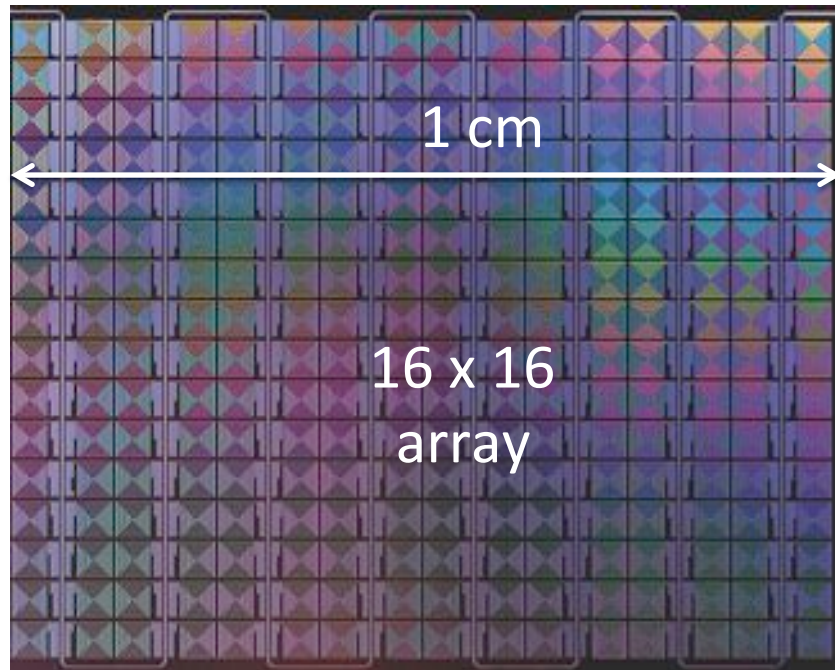
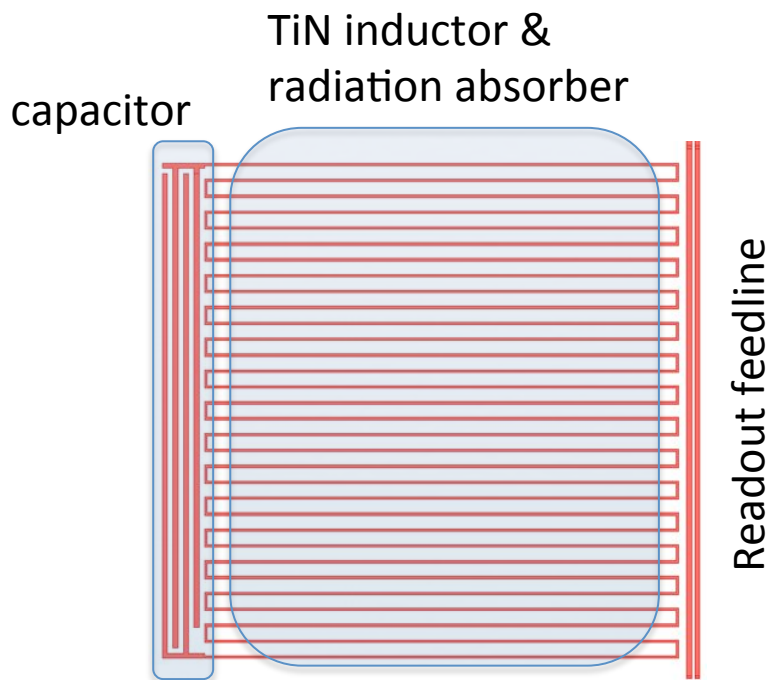

Response to 200 μm blackbody

$$h\nu/k = 72 \text{ K}$$

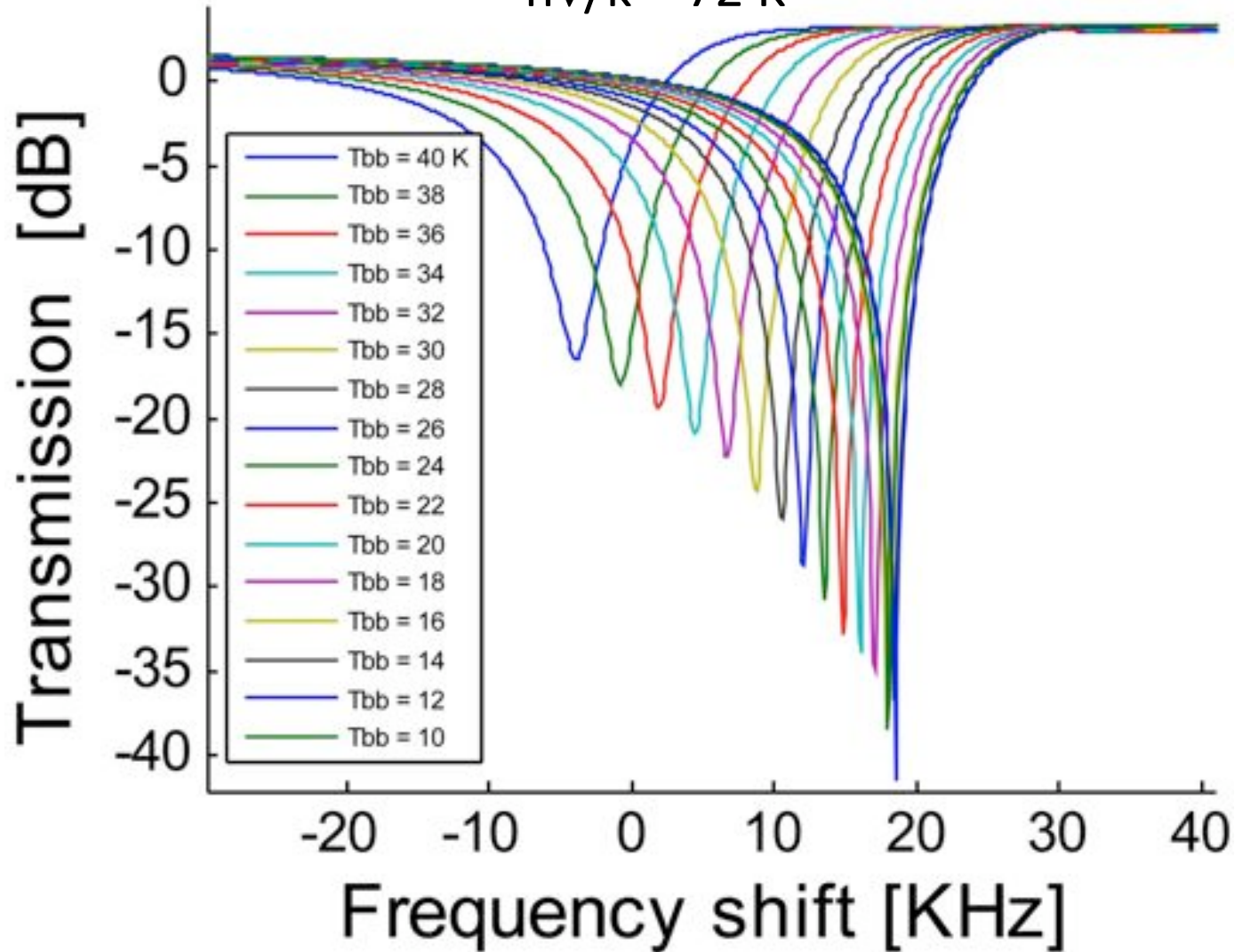

Readout electronics are available now

- CASPER/UCB ROACH hardware
- Custom ADC/DAC/IF boards
- 500 MHz bandwidth
- $> 10^6$ spectral channels using 2-stage FFT
- Used in MUSIC and NIKA

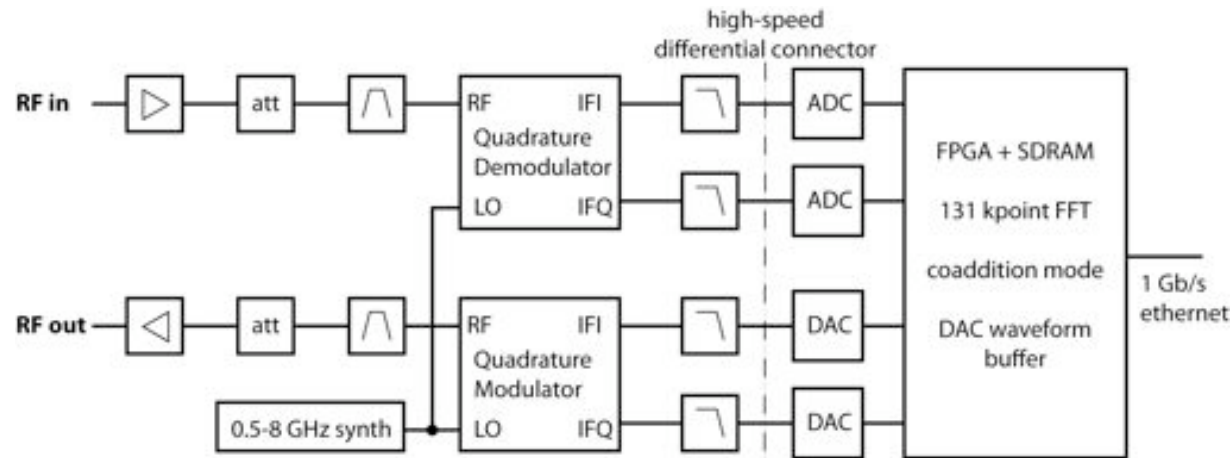

MUSIC & NIKA

(Maloney et al 2010, Proc SPIE 7741; Monfardini et al 2011, arXiv:1102.0870v2)

“... the 150 GHz LEKID array sensitivity is now comparable to the existing IRAM instrument MAMBO2 at Pico Veleta.”

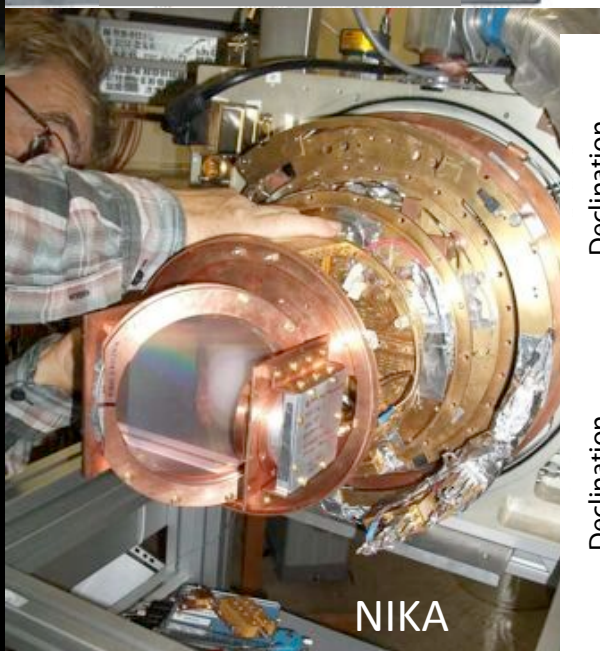
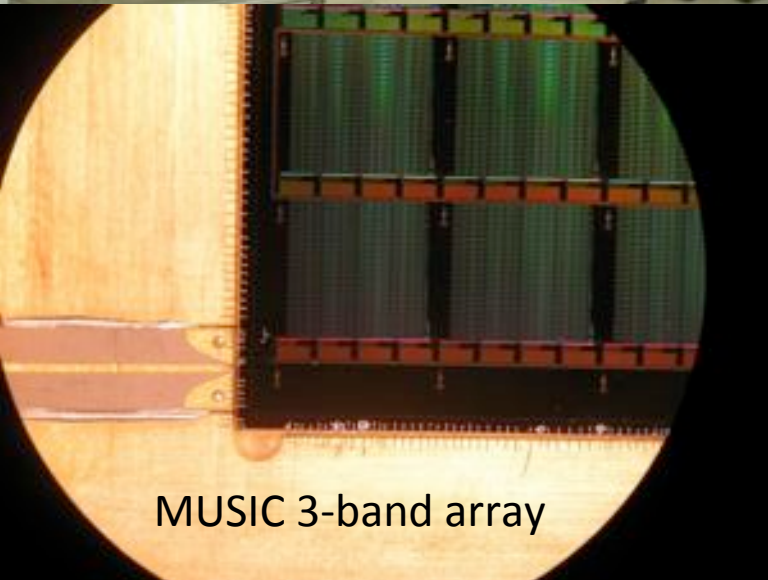
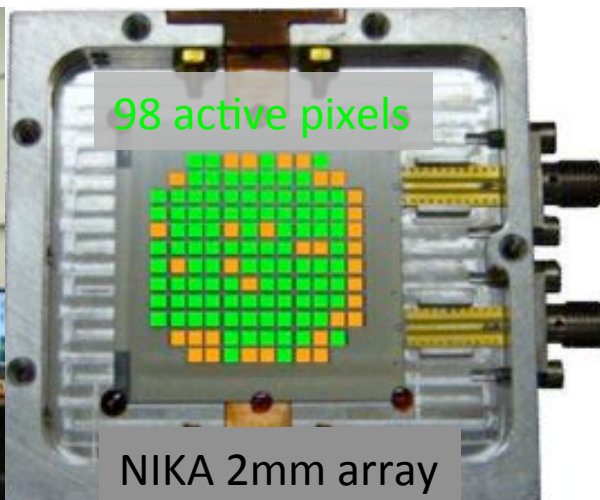

Average 2mm Radio Map SgrB2(FIR1)

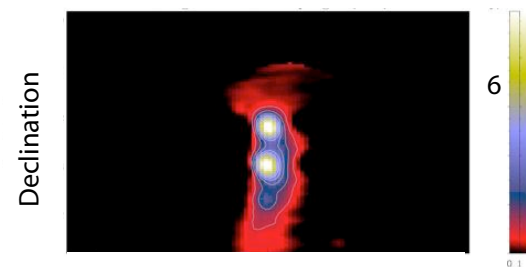

Average 1mm Radio Map SgrB2(FIR1)

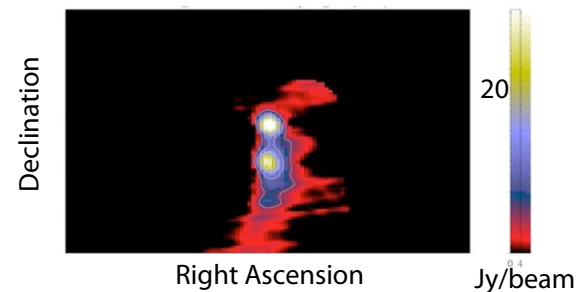

Primary surface



Use rings of keystone-shaped segments, so we have the option of replicating segments.

For simple 3-point support, segment size is limited to $\sim 2\text{m}$, so 6 rings, for a total of 162 segments.

Compound segment concept

aluminum tiles

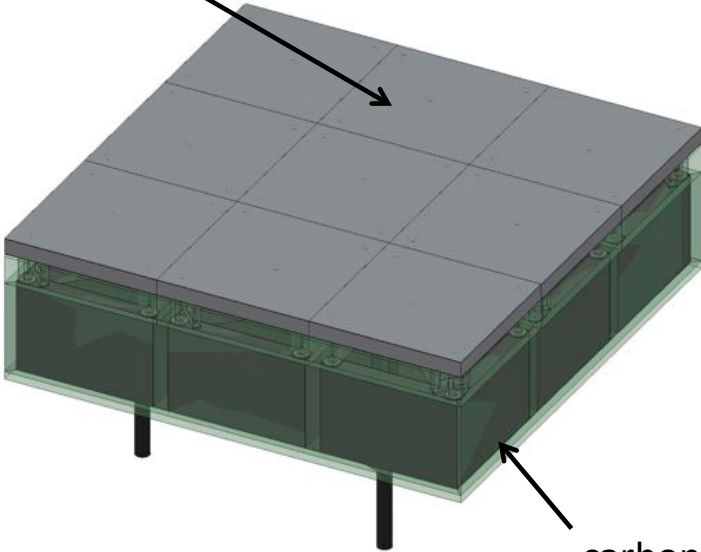

carbon-fiber frame

5 vertical adjusters

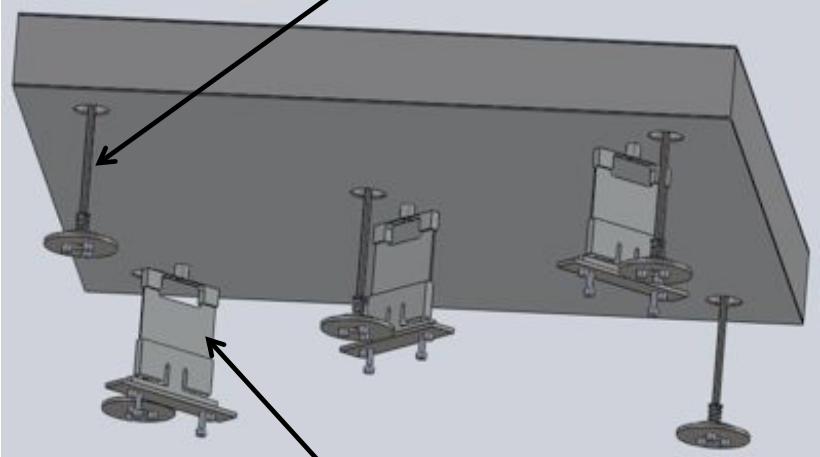

3 horizontal adjusters

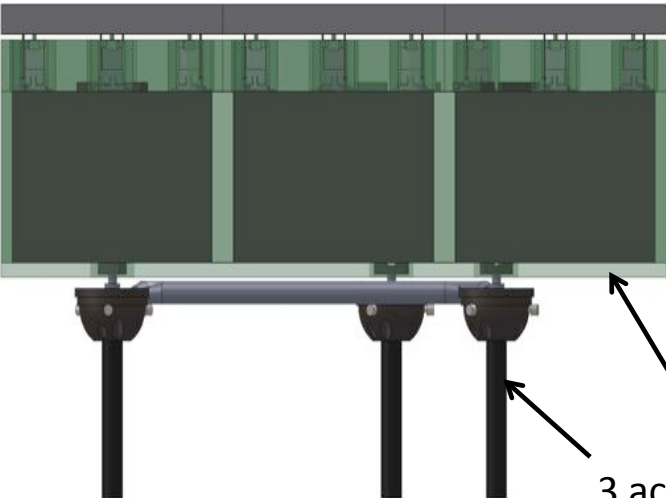

insulation

3 actuators

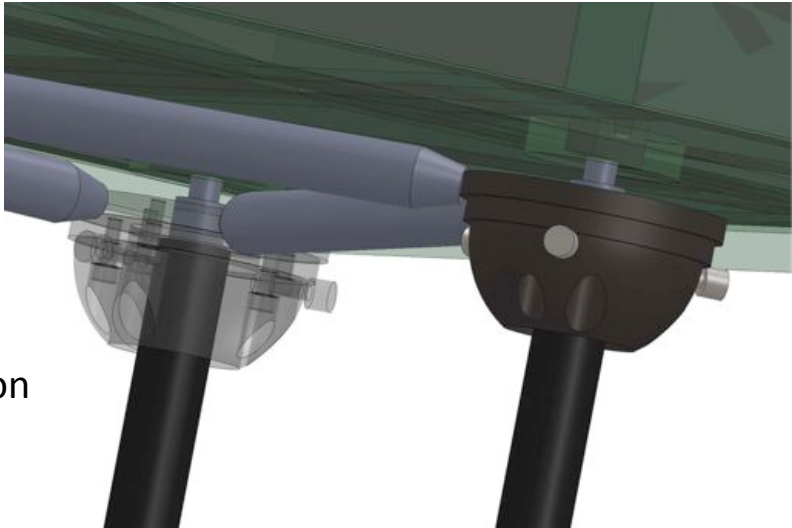

Prototype tile & subframe

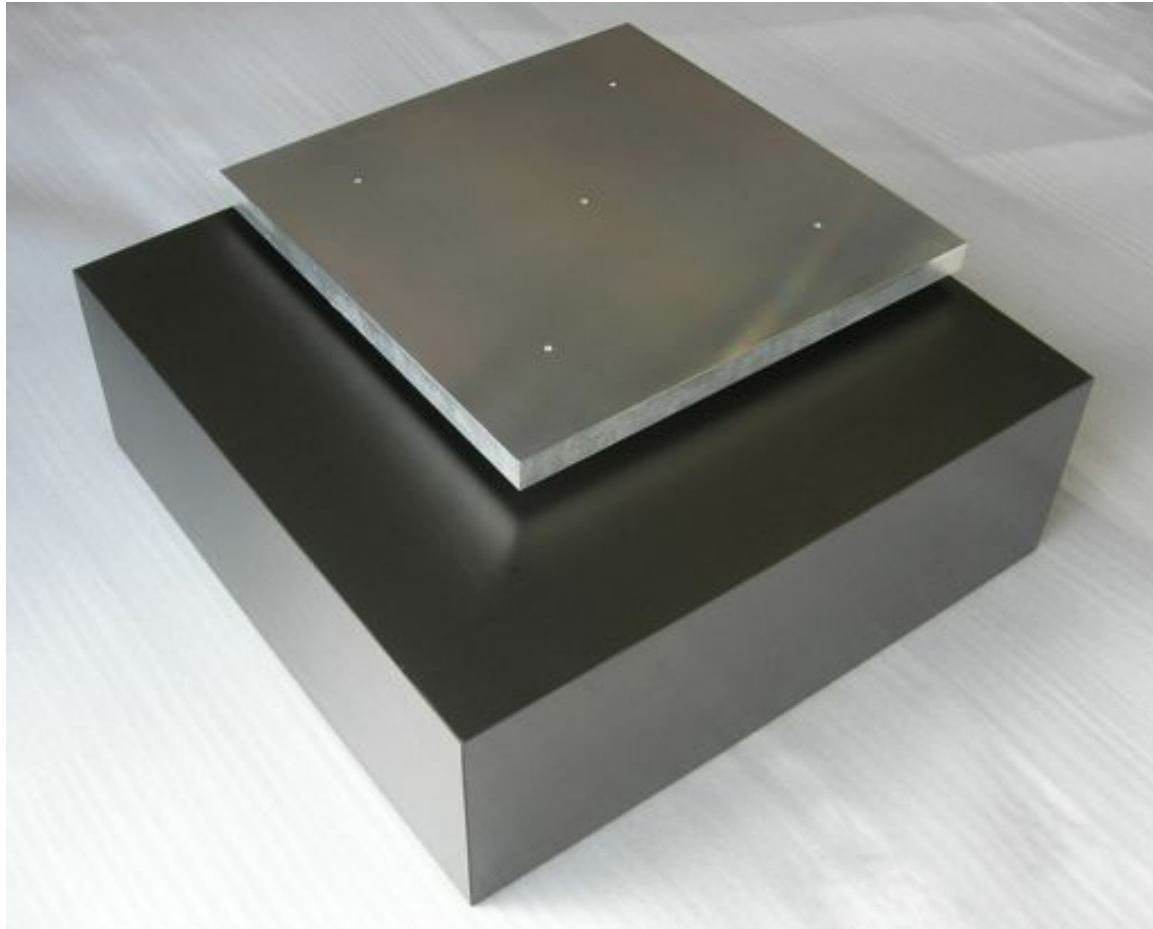

Tile surface error $2.5 \mu\text{m rms}$
Tile + subframe areal density 19 kg m^{-2}

Vertex Antennentechnik

Credit: S. Padin

CCAT vs ALMA

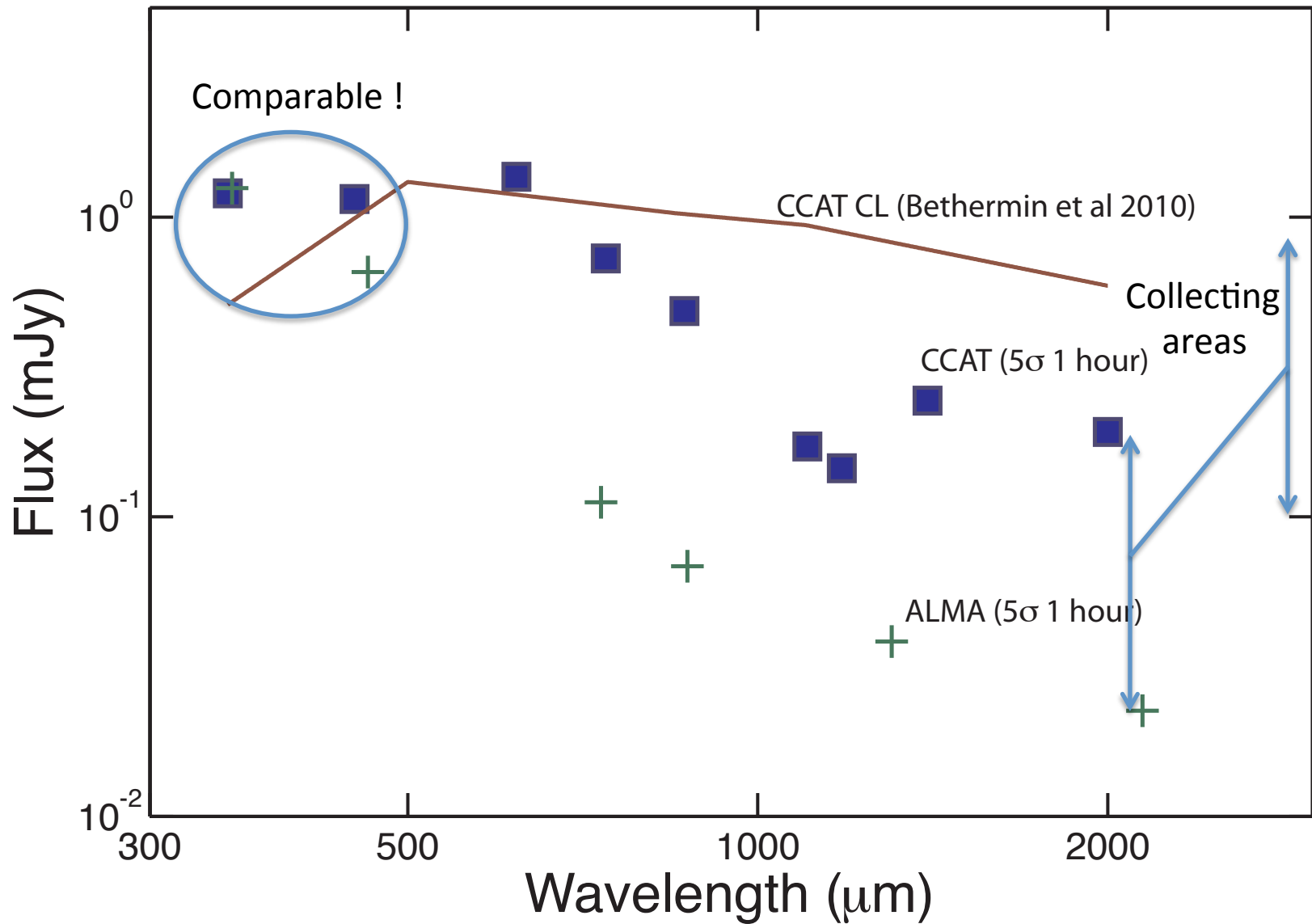

CCAT vs Herschel

350 μm

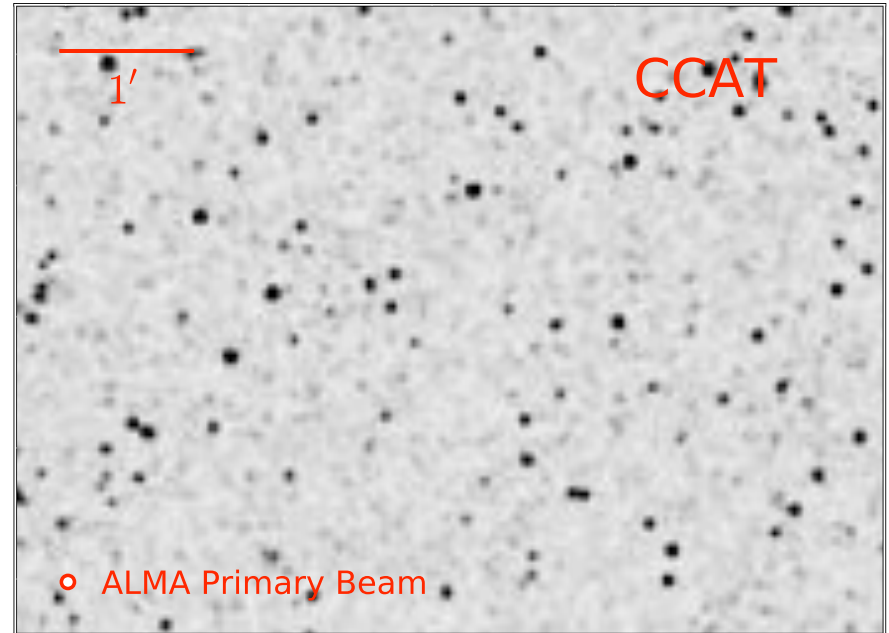
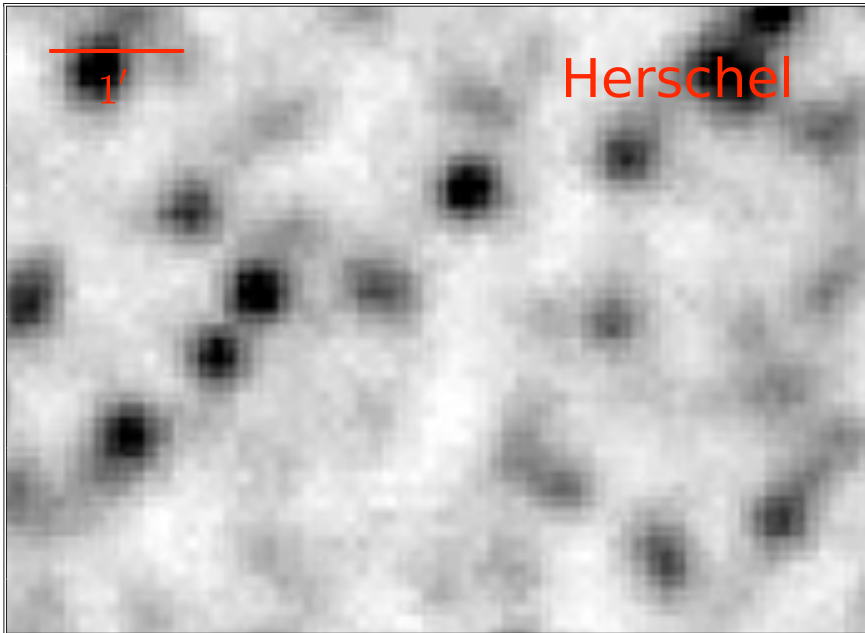

Cerro Chajnantor 5612 m



Cerro Chajnantor 5612 m

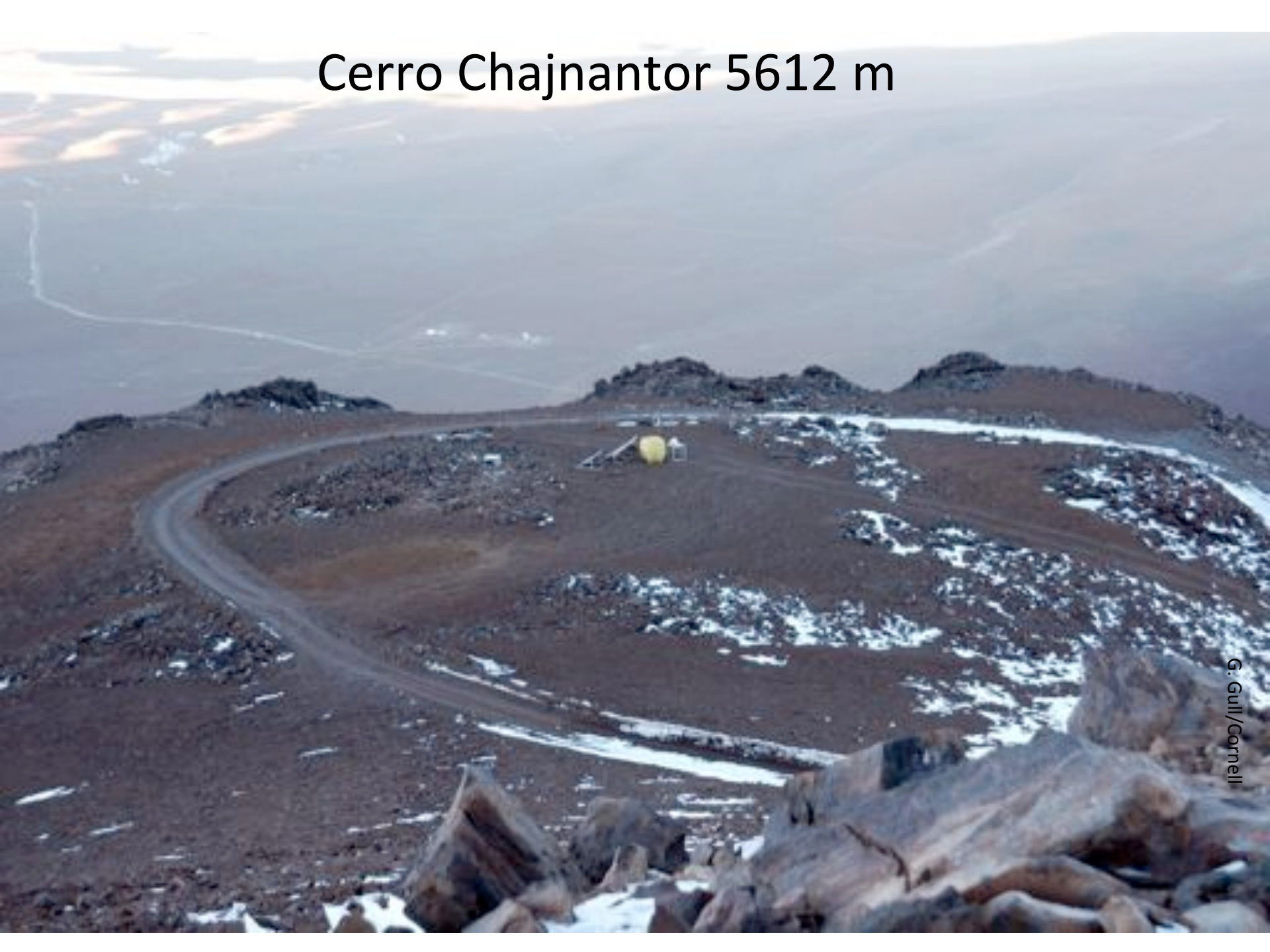

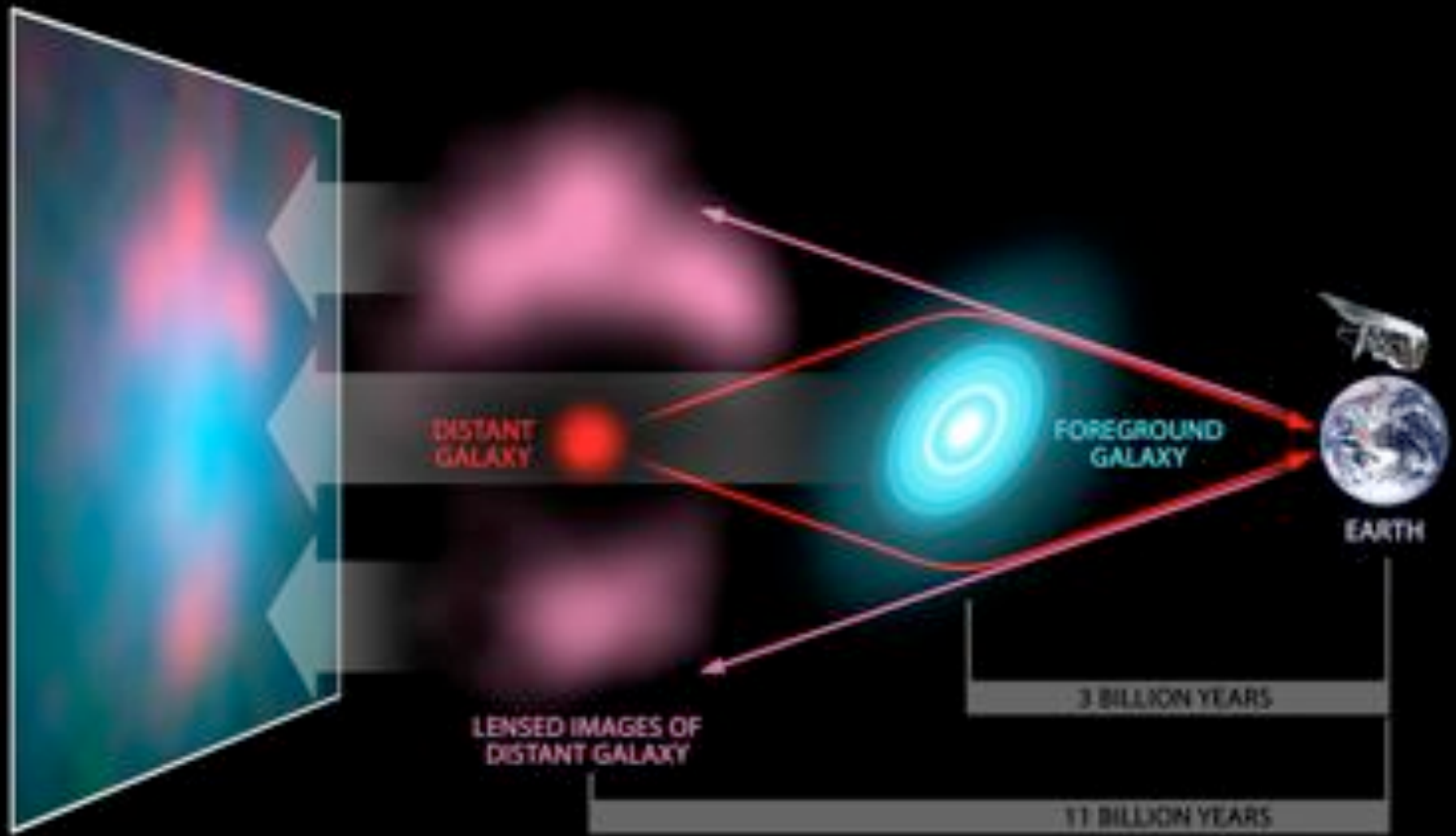

Z-Spec: wideband mm-wave direct detection spectroscopy

WaFIRS Grating:
 $62 \times 48 \times 3.3$ cm

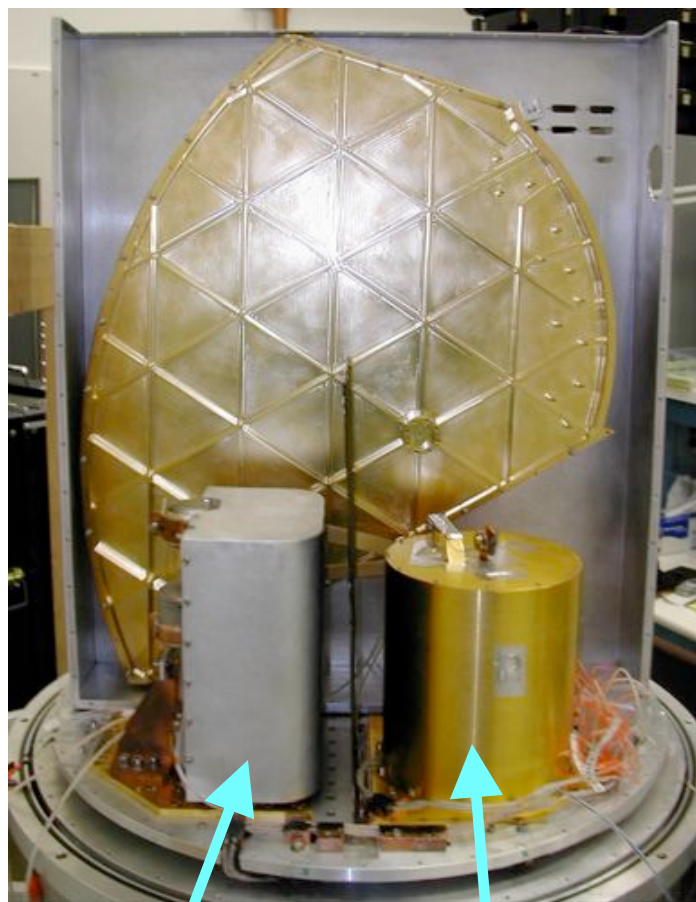

$^3\text{He}/^4\text{He}$
Fridge

60 mK ADR
(Salt pill courtesy Peter Timbie's group)

Parameters

- $\lambda = 1.0$ to 1.5 mm (CSO)
- 160 bolometers
- $\Delta\nu \sim 900$ MHz, $\Delta v \sim 1,000$ km s⁻¹

Background

- In 1998, the need for wideband mm/submm spectroscopy was clear following Scuba detections
- 1 mm window best choice for CSO
- Options: optical grating spectrometer, superconducting spectrometer chip
- Machined parallel-plate waveguide grating was the middle ground: Z-spec
- Superconducting spectrometer chip now appears very attractive – Golwala talk

Caltech—*Bret Naylor, Jonas Zmuidzinas*

Cardiff—*Peter Ade*

CEA (France)—*Lionel Duband*

Colorado—*James Aguirre, Lieko Earle, Jason Glenn, Phil Maloney, Corey Wood*

JPL—*Jamie Bock, Matt Bradford, Hien Nguyen*

ISAS (Japan)—*Hideo Matsuhara*

Credit: M. Bradford

Summary

- CCAT is designed for submm surveys
 - Wide field of view
 - High sensitivity (25 m, excellent site)
 - Good angular resolution ($3''.5$ at $350\ \mu\text{m}$)
 - Broad wavelength coverage
- Leading-edge instruments
 - Wide-field cameras
 - Multi-object or integral-field spectrometers
- Aiming for completion by 2018
- See www.submm.org